

VG-274J

Alternator

EMEAN
POWER

Performance Data

Brand	EMEAN
Technology Genuine	Stamford copy
Model	VG-274J
Standby power	309KVA
Rated power	225KW
Frequency	60HZ
RPM	1800
Power factor(cos Φ)	0.8
Efficiency	<u>93.70%</u>
Insulation system	Class H
Protection	IP23
Rotor	Single bearing
Winding Connections	Star/Y, 4 wires
Excitation system	Self-excited
Voltage regulator	A.V.R SX440
Altitude	$\leq 1000\text{m}$
Voltage Stabilized regulation	$\leq \pm 1.5\%$
Voltage Instantaneous regulation	$\leq \pm 20\%$
Voltage Recovery time (s)	≤ 1
Voltage Fluctuation ratio	$\leq 1\%$
Voltage Wave aberration ratio	$\leq 5\%$
Frequency Stabilized regulation	$\leq 1\%$ (adjustable)
Frequency Instantaneous regulation	-10%~12%
Frequency Fluctuation ratio	$\leq 1\%$



Brushless Alternator



Cold-rolled Sheet



Big Shaft & Copper Wire

www.emeanpower.com
Email: sale5@fjepos.com
Phone: +86 19890349907

WHATSAPP



WECHAT



Alternator

Exploded Drawing

EMEAN
POWER

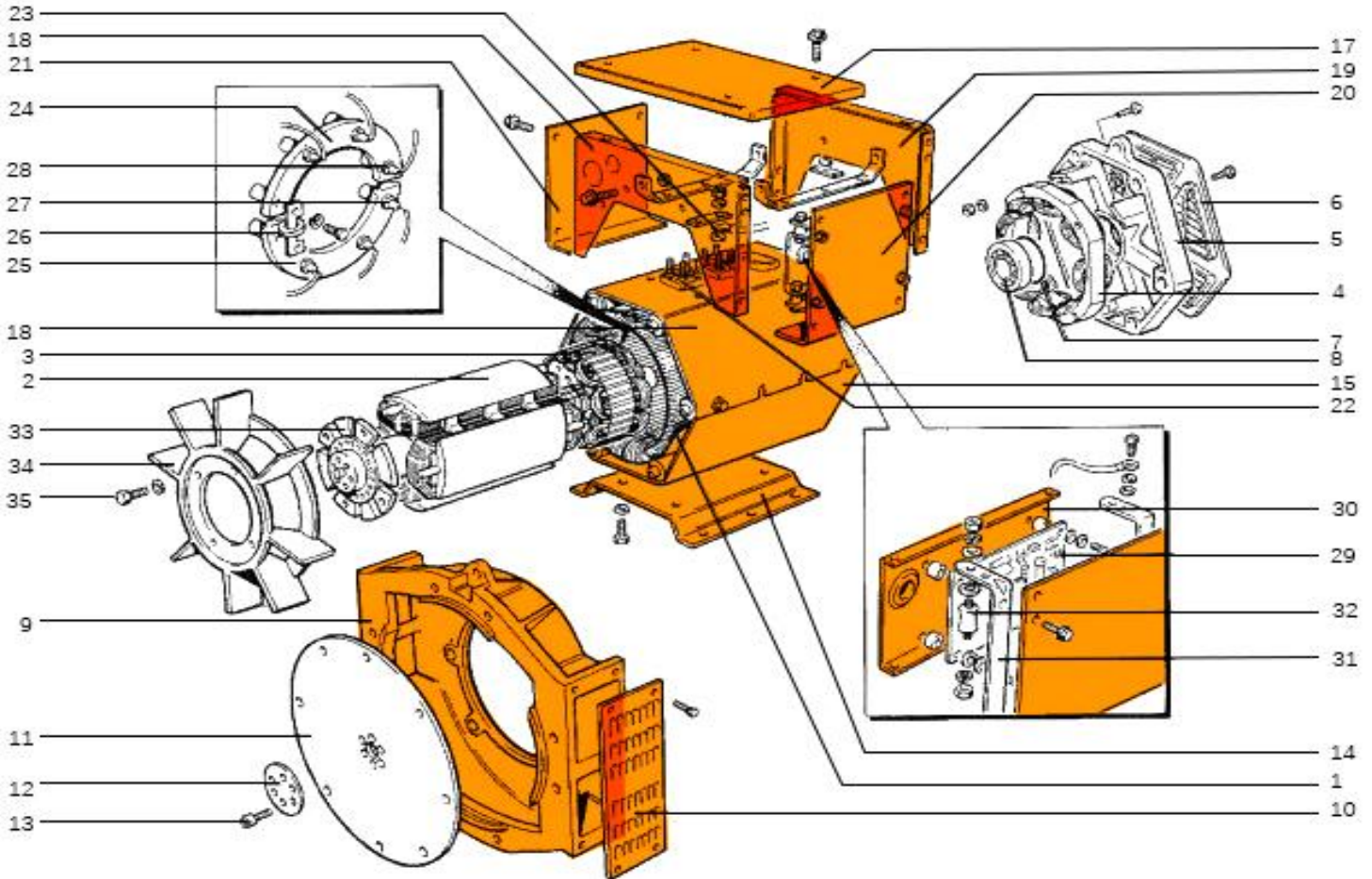

1.Stator

2.Rotor

3.Excitation rotor

4.Excitation stator

5.NDE cap

6.NDE cover

7.NDE bearing O-ring

8.NDE bearing

9.Drive end flange adaptor

10.Drive end window board

11.Coupling disc

12.End ring

13.Coupling screw

14.Base

15.Bottom cover

16.Shell

17.Cover

18.Front Plate

19.Terminal box NDE plate

20.AVR plate

21.Plate

22.Main wiring board

23.Terminal connection

24.Rectifier (forward)

25.Rectifier(reverse)

26.Varistor

27.Diode reverse

28.Diode forward

29.AVR

30.AVR mounting plate AVR

31.AVR mounting brackets AVR

32.Shockproof block

33.Fan base

34.Fan

35.Fan fastening screw

www.emeanpower.com

Email: sale5@fjepos.com

Phone: +86 19890349907

WHATSAPP



WECHAT

